

5A 2-4 Cell Buck-Boost Switching Battery Charger Evaluation Board

General Description

The Evaluation Board demonstrates that the RT9490WSC is designed for a highly-integrated 5A Buck-Boost switch mode battery charge management and system power path management device for 2-4 cell Li-Ion and Li-polymer batteries. The low impedance power path optimizes switch-mode operation efficiency, reduces battery charging time, and extends battery life during the discharging phase. The I²C serial interface with charging and system settings makes the device a truly flexible solution.

Table of Contents

General Description	1
Performance Specification Summary	2
Detailed Description of Hardware	3
Quick Start Procedure	6
Evaluation GUI Software Tool Installation and Introduction	8
Test Procedure	12
Typical Applications	22
Bill of Materials.....	23
Evaluation Board Layout.....	25
More Information.....	29
Important Notice for Richtek Evaluation Board.....	29

Performance Specification Summary

Summary of the RT9490WSC Evaluation Board performance specification is provided in Table 1. The ambient temperature is 25°C.

Table 1. RT9490WSC Evaluation Board Performance Specification Summary

Specification	Test Conditions	Min	Typ	Max	Unit
Supply Input Voltage Range		3.6	--	24	V
Maximum Input Current		--	--	3.3	A
Maximum OTG Current	OTG mode	--	--	3.32	A
Maximum Output Current	(SW2), ISYS	--	--	5	A
Maximum Battery Voltage		--	--	18.8	V
Maximum Charge Current		--	--	5	A
Maximum Discharge Current		--	--	10	A

Detailed Description of Hardware

Headers Description and Placement

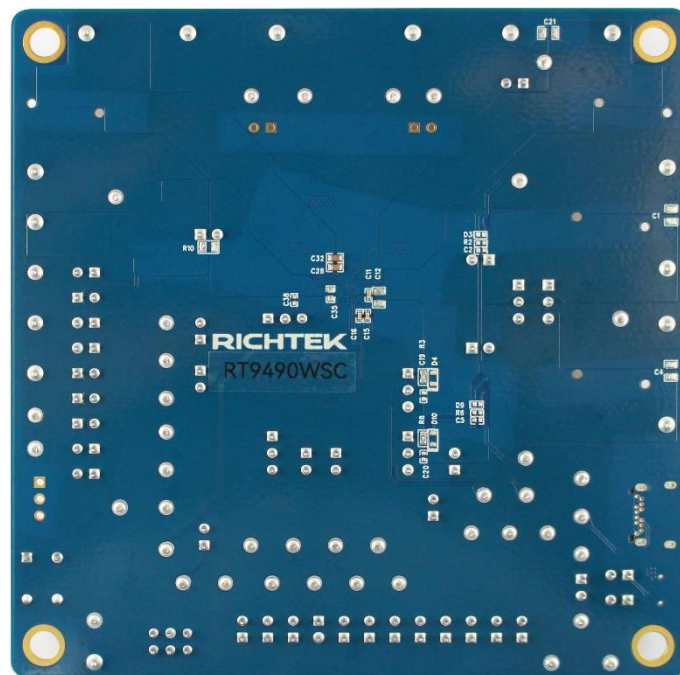
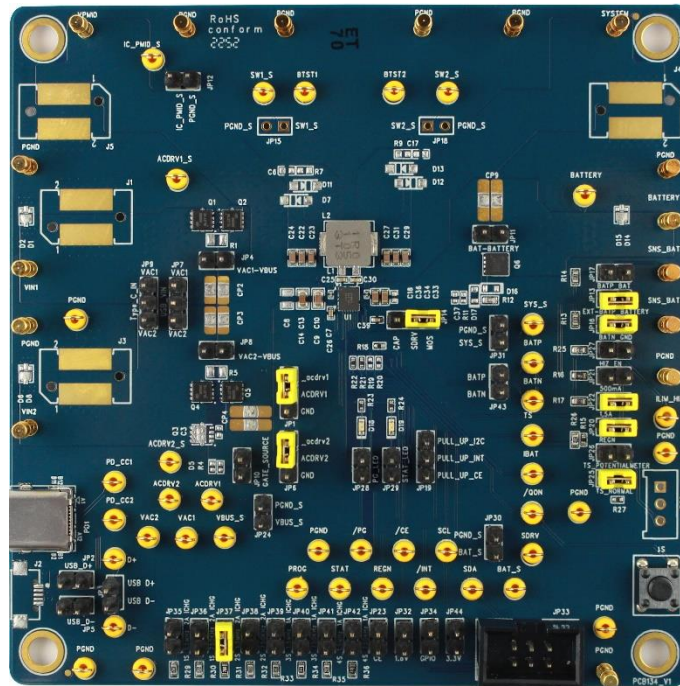

Carefully inspect all the components used in the EVB according to the following Bill of Materials table, and then make sure all the components are undamaged and correctly installed. If there is any missing or damaged component, which may occur during transportation, please contact our distributors or e-mail us at evb_service@richtek.com.

Test Points

The EVB is provided with the test points and pin names listed in the table below.

Test Point/ Pin Name	Function
VIN1	Input voltage for VAC1.
PGND	Ground.
VIN2	Input voltage for VAC2.
SYSTEM	Output voltage for sys.
BATTERY	Battery connection point.
SNS_BATP	External battery positive sense.
SNS_BATN	External battery negative sense.
PD1	USB Type-C port.
JP7	Type-C USB BUS tied to VAC1 or VAC2 jumper.
JP9	Micro USB BUS tied to VAC1 or VAC2 jumper.
JP14	SDRV tied to ship FET or 1nF capacitor.
JP19	Pull up for I2C/INT/CE.
JP1	ACDRV1 pull-low jumper.
JP6	ACDRV2 pull-low jumper.
JP4	VAC1-VBUS short jumper.
JP8	VAC2-VBUS short jumper.
JP2	USB_D+ jumper.
JP5	USB_D- jumper.
JP11	BAT-BATTERY short jumper.
JP13	BATP tied to drain of ship FET jumper.
JP16	BATP tied to GND or external battery negative sense jumper.
JP17	BATP tied to BAT pin jumper.
JP20	REGN for TS circuit pull high jumper.
JP21	Test resistance jumper with 500mA for ILIM_HZ function.
JP22	Test resistance jumper with 1.5A for ILIM_HZ function.
JP23	CE pull-low jumper.
JP25	Test resistance jumper with TS_NORMAL for JEITA.
JP26	Test resistance jumper for with TS_POTENTIOMETER JEITA.
JP27	Test resistance jumper for ILIM_HZ function
JP28	PG_LED enable jumper.
JP29	STAT_LED enable jumper.
JP35	This header is for part number RT9490S.
JP36	This header is for part number RT9490S.
JP37	PROG resistance jumper for default set 2S_1.5MHz_2A ICHG.
JP38	PROG resistance jumper for default set 2S_750KHz_2A ICHG.
JP39	PROG resistance jumper for default set 3S_1.5MHz_1A ICHG.

Test Point/ Pin Name	Function
JP40	PROG resistance jumper for default set 3S_750KHz_1A ICHG.
JP41	PROG resistance jumper for default set 4S_1.5MHz_1A ICHG.
JP42	PROG resistance jumper for default set 4S_750KHz_1A ICHG.
CP2	VAC1-VBUS short pad.
CP3	VAC2-VBUS short pad.
CP9	BAT-BATTERY short pad.
S1	Button for exit ship mode or system reset.

Default Jumper Setting on EVB

Jumper	Description
JP1	Short ACDRV1 to _acdrv1.
JP6	Short ACDRV2 to _acdrv2.
JP13	Short BATP to BATTERY.
JP14	Short SDRV to MOS.
JP16	Short BATN to GND.
JP20	Short REGN to TS pull-up resistor.
JP25	Short TS to normal temperature resistor.
JP22	Short ILIM for 1.5A.
JP37	For 2 cell/1.5MHz setting.

Quick Start Procedure

Suggestion Required Equipments

- RT9490WSC Evaluation Board
- DC power supply capable of 24V, 3.3A
- Battery simulator capable of 18.8V, 10A
- Electronic load capable of 10A
- Oscilloscope

Evaluation Board Jumper Setup

The Evaluation Board is fully assembled and tested. Follow the steps below to verify board operation. Do not turn on supplies until all connections are made. When measuring the output voltage ripple, care must be taken to avoid a long ground lead on the oscilloscope probe. Measure the output voltage ripple by touching the probe tip and ground ring directly across the last output capacitor.

1. Use jumpers on JP37 to JP42 to set battery cells and switching frequency for default charging profile.

Battery Cell (s)	Switching Frequency	Jumper No.
2S	1.5MHz	JP24
	750kHz	JP25
3S	1.5MHz	JP26
	750kHz	JP27
4S	1.5MHz	JP28
	750kHz	JP29

2. Use jumpers on JP1 and JP6 to connect ACDRV1 and ACDRV2 to the gate driver output from IC. If the external AC-RBFETs are not needed, use jumpers on JP4 and JP8 to bypass them and JP1 and JP6 should be used to connect ACDRV1 and ACDRV2 to GND.
3. Use a jumper on JP14 with Mid-Right side to connect SDRV to the gate driver output from IC. If the external ship FET is not needed, use a jumper on JP11 to bypass it and use JP14 with Mid-Left side to connect SDRV to the capacitor.
4. Use a jumper on JP25 (TS_NORMAL) or JP26 (TS_POTENTIOMETER) for setting TS pin configuration and JP20 for connecting to REGN as pull-up voltage.
5. Use a jumper on JP21 (500mA) or JP22 (1.5A) for ILIM setting and JP27 for controlling HIZ_EN.
6. Use a jumper on JP16 to connect BATN to PGND.
7. Use a jumper on JP13 for connecting BATTERY to BATP when the external ship FET is adopted.
8. Use a jumper on JP17 for connecting BAT to BATP when the external ship FET is not adopted.
9. Use a jumper on JP9 for connecting Type_C_IN on VAC1 or VAC2.

Proper measurement equipment setup and follow the procedure below.

1. With power off, connect input power and ground to VIN1 or VIN2 and PGND respectively.
2. With load off, connect electronic load to SYSTEM and PGND respectively.

3. With power off, connect power and ground to BATTERY and PGND respectively. Turn on battery simulator, then the device is powered up.
4. Use I²C to set registers for charging function and proper protection level. Richtek also provides designers GUI software tool to read or write registers. The details are shown in the next chapter " Evaluation GUI Software Tool Installation and Introduction".
5. Turn on the input power supply to start charging. Make sure that the power supply voltage is under OVP level.
6. Check the output charging current using a current meter.
7. Once the proper charging current is established observe the output voltage regulation, ripple voltage, efficiency and other performance.
8. For testing SYS load, turns on the electronic load and adjusts SYS current.

Evaluation GUI Software Tool Installation and Introduction





The function settings of the RT9490 are not only hardware pins but also software register settings. The RT9490 register is set via I²C communication. To test evaluation board conveniently, Richtek provides GUI tool and users can use it to read and write the register. Follow the below steps to install the relative software tools.

1. Richtek Bridgeboard Utilities Installation

Get the Richtek Bridgeboard Utilities, user manual and purchase the bridge board from the website.

https://www.richtek.com/Design%20Support/Reference%20Design/RD0001-01?sc_lang=en











Please follow the user manual to install the Richtek Bridgeboard Utilities.

Title	Last Update	Share	Download
User Manual	2022/08/25		
Richtek Bridgeboard Utilities	2023/03/21		

2. Download the GUI

Get the RT9490 GUI from website.

https://www.richtek.com/Design%20Support/Reference%20Design/UG9490WSC?sc_lang=en

Overview	Design Resources	Related Product	Sample & Buy
Title	Last Update	Share	Download
Evaluation Board User Guide	2023/06/01		
Bill of Materials	2023/06/01		
Schematic	2023/06/01		
Gerber File	2023/06/01		
RT9490 GUI Control Panel	2024/04/03		

3. The introduction of GUI interface is as below.

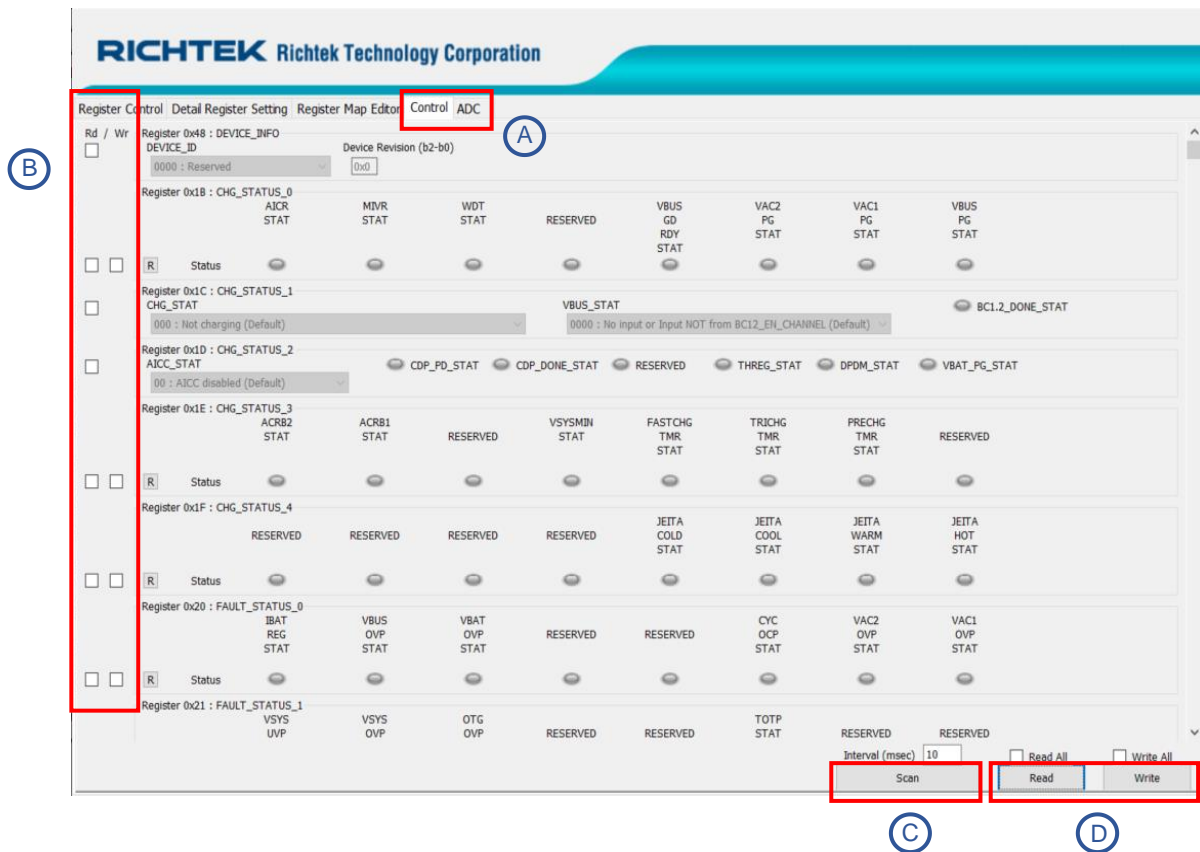

A:
All registers can be read/written in these pages.

B:
You can select which byte you want to read/write in this column.

C:
The selected register will continue to be read after click the scan button.

D:
Write: The selected register will be written to the device after click the write button.
Read: The selected register will be updated after click the read button.

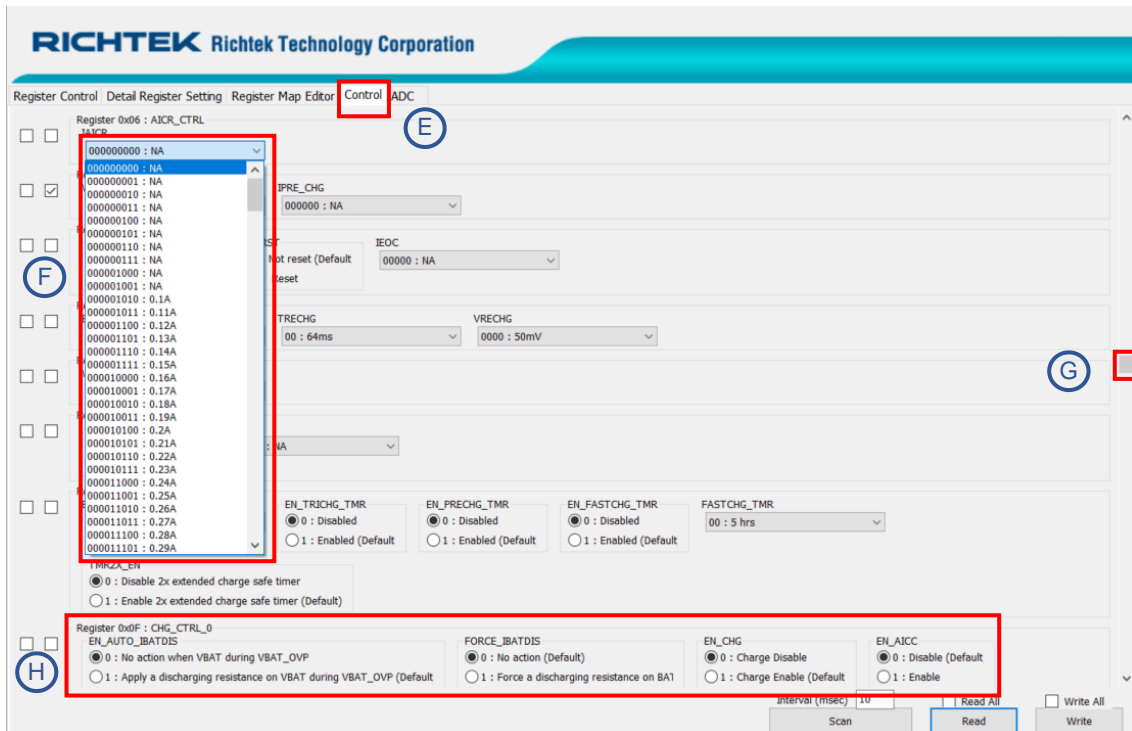

E:
This page is for charging behavior setting.

F:
This type of dropdown menu allows you to select the setting you need.

G:
You can scroll down/up to select the register setting.

H:
This type of menu allows you to select the bit setting you need. A solid fill indicates your selection.

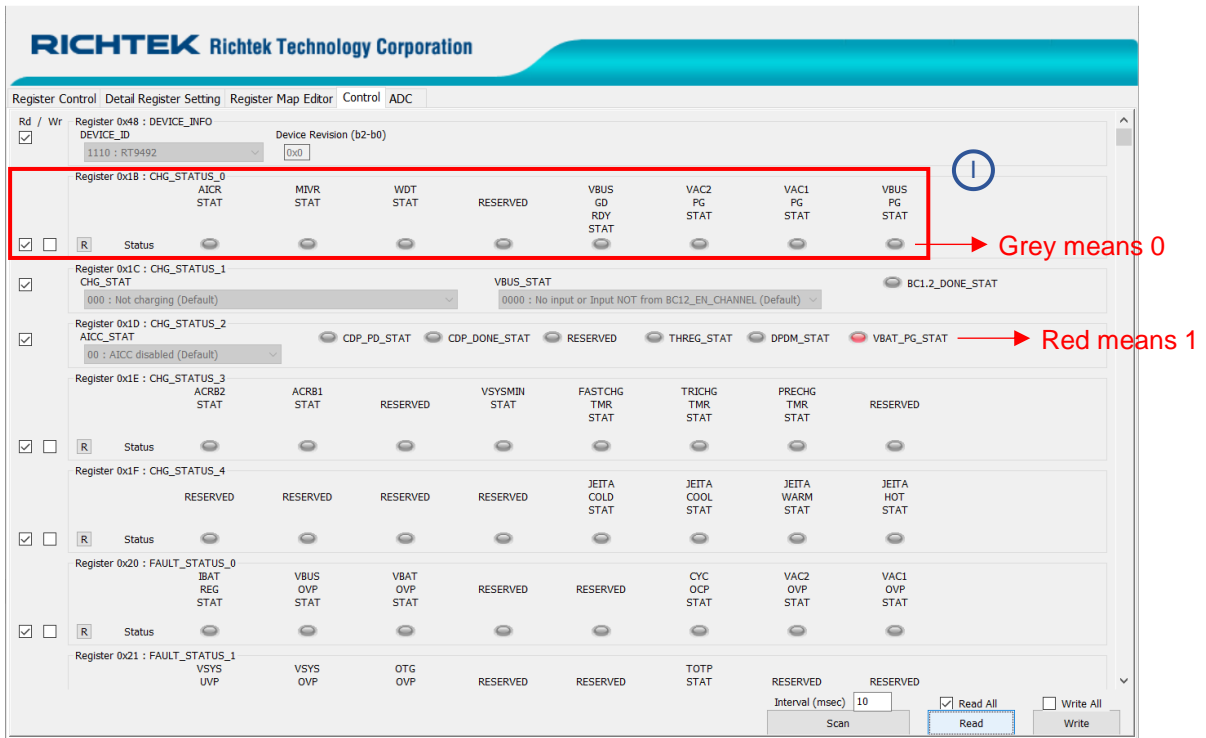

I:
These lamp icon are STATUS type of register.

Test Procedure

Hardware Initial Settings

1. Follow the section “Evaluation Board Jumper Setup” to set the board jumper.
2. Use a battery simulator or a real battery to power up the RT9490 at the BATTERY pin. The voltage should be within the application range. For example, in 2-cell application, users can initially provide 8V to the BATTERY pin.

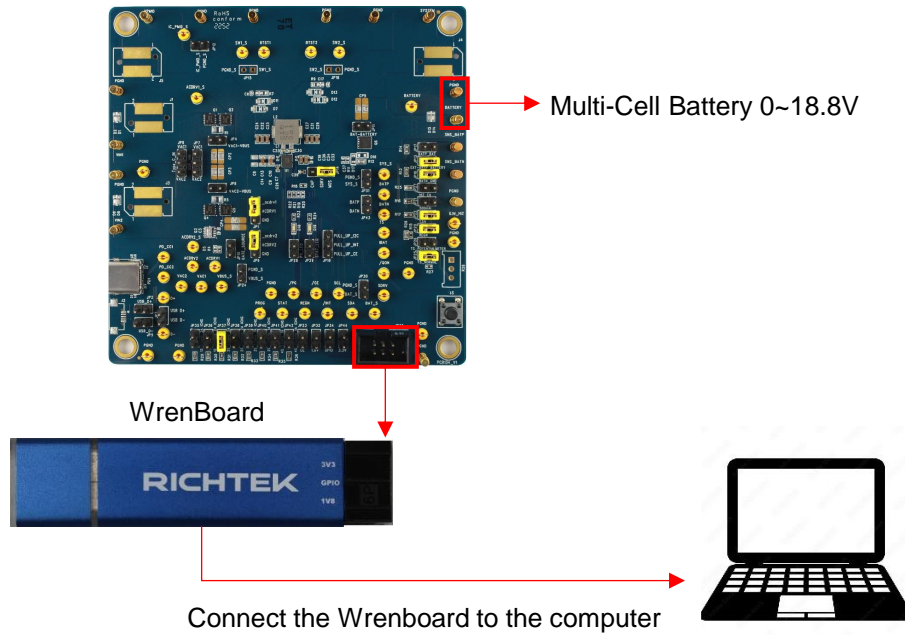

GUI Setup

1. Follow the section” Evaluation GUI Software Tool Installation” to Install the GUI tool.
2. Connect Richtek Wrenboard to evaluation board through JP33 SCL/SDA/PGND pin.
3. Connect Richtek Wrenboard to the computer.

4. After providing power to the Evaluation Board, run the RT9490_RT9490S_GUI_V4.exe.

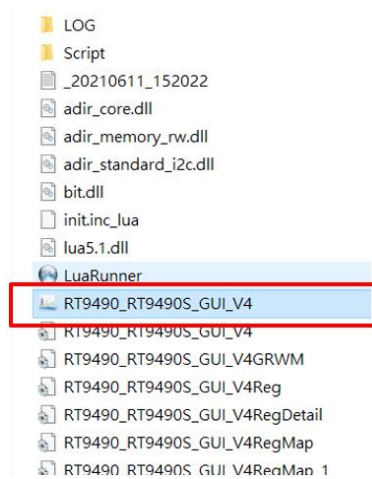

5. If GUI connection is successful, the slave address ID will show 0x53.

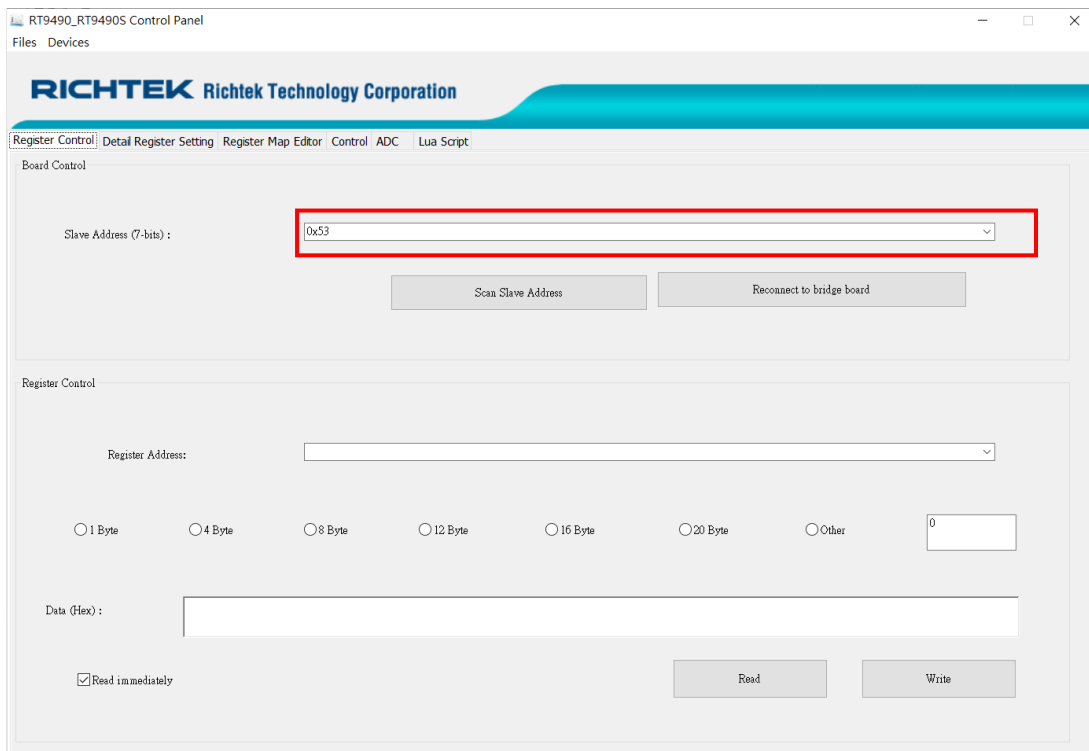

Register Initial Setting

- For board evaluation, disable watchdog initially if don't want to verify watchdog function.

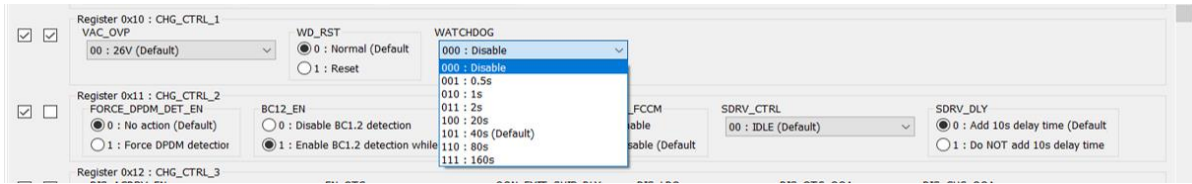

- Check whether BATTERY_CELL setting is the same as PROG pin setting. This register can also be changed after powered up.

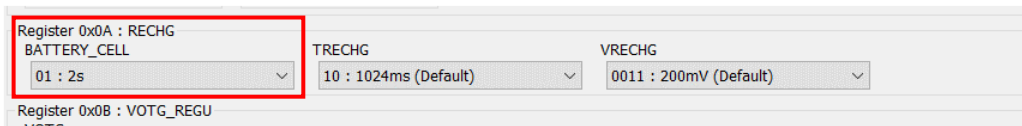

- Set VSYSTEMIN for Buck-Boost sys pin minimum regulation level. Set it as minimum system voltage.
- Set VBAT_REG for battery full charged level.
- Set ICHG_CTRL for fast charge current level.
- Set VMIVR for input voltage limitation level. Set it lower than test input voltage.
- Set IAICR for input current limitation level. Set it lower than test input source current limit.

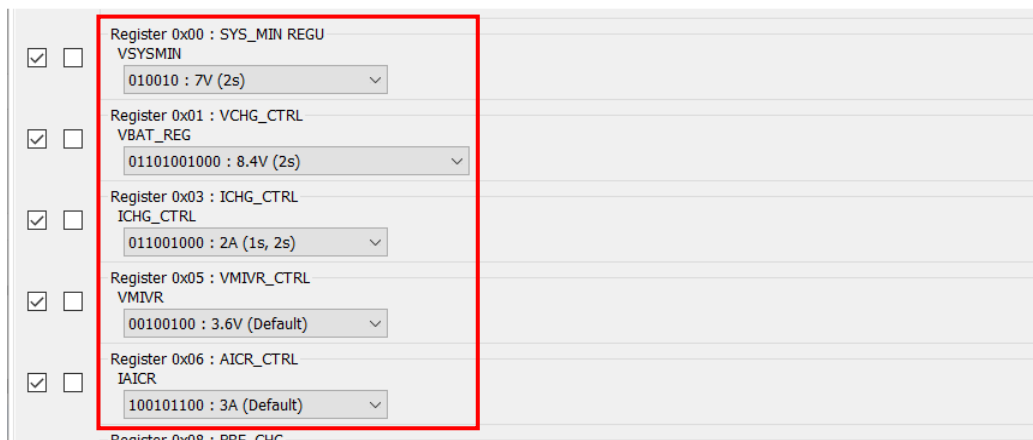

- Set the IEOC for charging termination level.

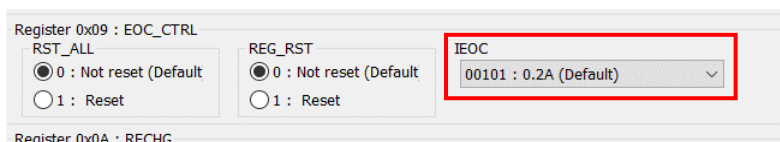

9. Check whether VAC_OVP level is large enough. It should be bigger than VBUS input voltage.



10. The charger input current limit is decided by the minimum value between AICR and ILIM. If do not want to verify the ILIM_HZ function, disabled ILIM_HZ function.

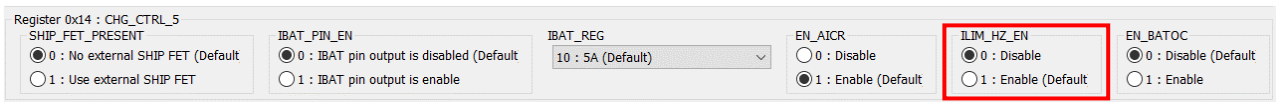

Charger Function Test

1. After finishing register initial setting, give VAC1 or VAC2 pin input power to start charger. For example, give it 15V.

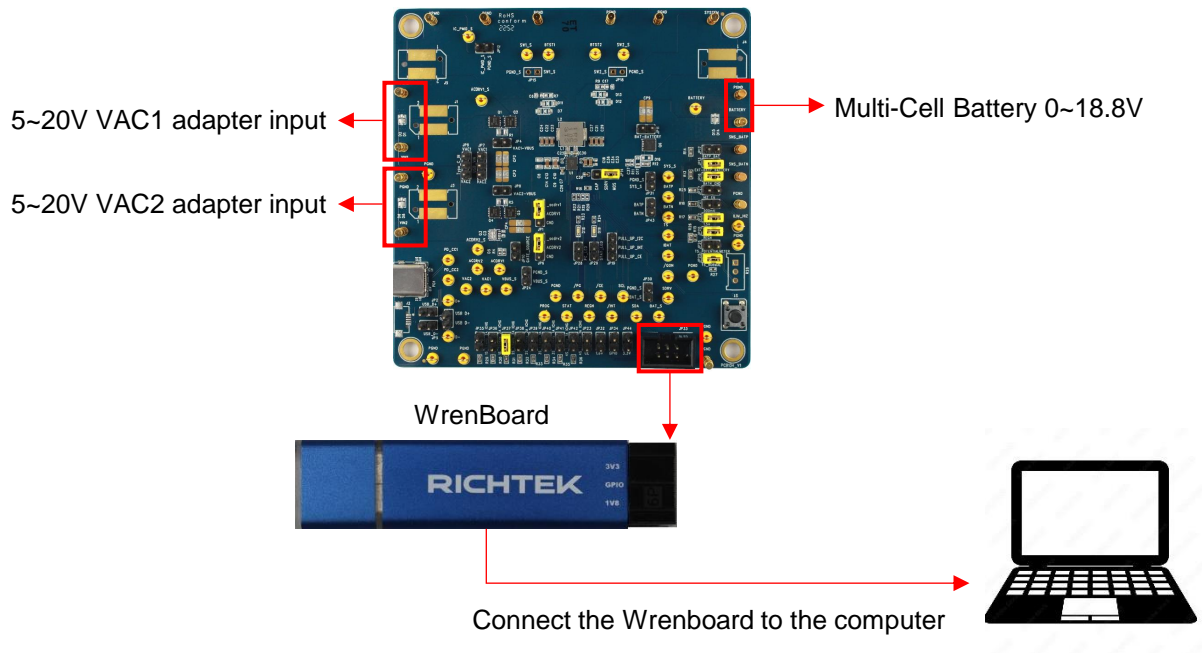

2. Check whether it triggers AICR_STAT, MIVR_STAT, or other protections.

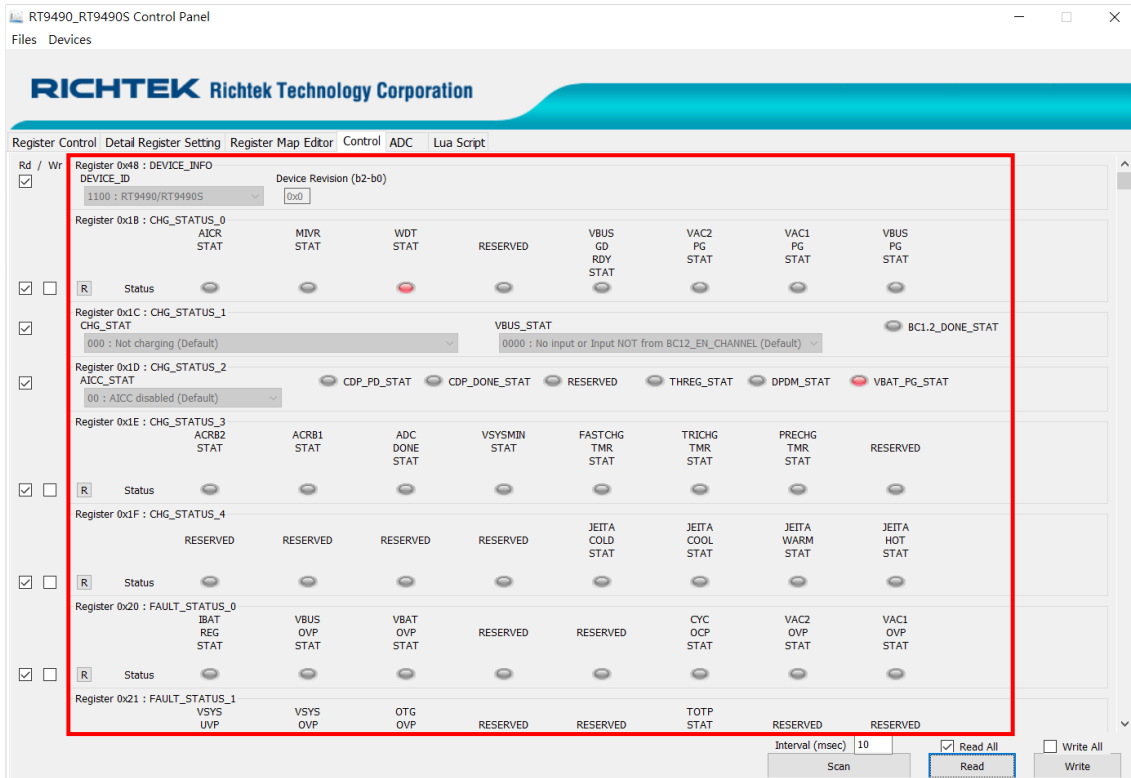

3. If it triggers AICR_STAT, it means that the input current is near limitation level. Increase input voltage or reduce ICHG_CTRL setting to leave AICR_STAT.
4. If it triggers MIVR_STAT, it means that the input power is not enough and input source voltage drops. Increase input power ability or reduce ICHG_CTRL setting to leave MIVR_STAT.
5. Check the CHG_STAT. In CC mode, the charging current will be regulated as register ICHG_CTRL if it doesn't have AICR_STAT and MIVR_STAT.

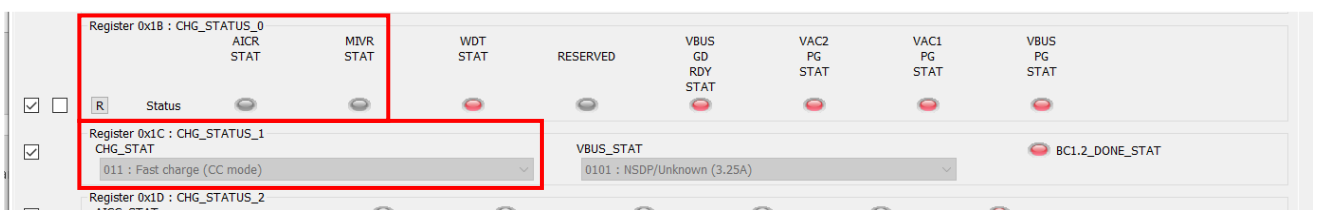

6. Measure the BAT pin output current to verify the fast charge current.
7. Gradually increase battery simulator voltage to simulate battery charging.
8. Measure the charging current and the BATE pin voltage as the battery voltage increases. Once the charging current starts to fall down, verify that the voltage remains at the VBAT_REG level (IR drop + VBAT = VBAT_REG level).

9. Check that CHG_STAT is into CV mode.

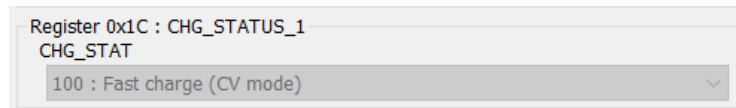

10. Continue increasing the battery voltage. Check that the BAT charging current is gradually down in CV mode.

11. After BAT charging current is below IEOC level, the RT9490 will stop charging.

12. CHG_STAT will show Charge_done at this full-charged stage.

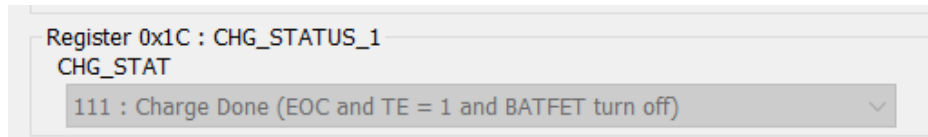

13. If EN_TE is disabled at initial setting, the IEOC function will not work at this stage. The RT9490 will not stop charging and will continue charging until the current decreases to 0A.

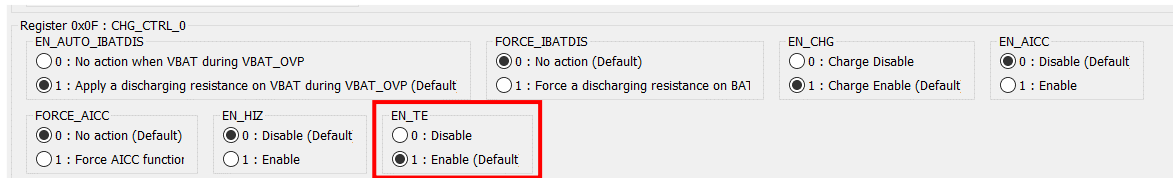

14. To verify the recharge function, load the SYS pin to discharge the battery or reduce the voltage of the battery simulator.

15. The recharge level is determined by the VRECHG register.

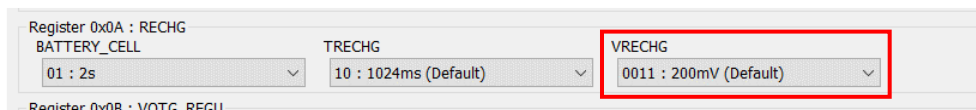

16. After battery voltage is below (VBAT_REG-VRECHG), the RT9490 will start to charge again. For example, VBAT_REG is 8.4V, VRECHG is 200mV and the recharge level will be 8.2V.

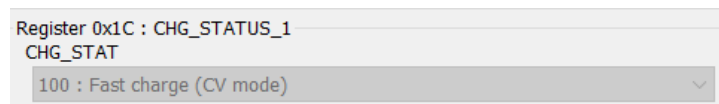

17. Plug out the VAC input power. RT9490 will stop charging.

OTG Function Test

1. Finish register initial setting as section "Register initial setting".
2. Make sure the battery voltage is above VOTG_LBP (typ. 2.7V). For example, provide it 8V.

3. Set the OTG voltage level.

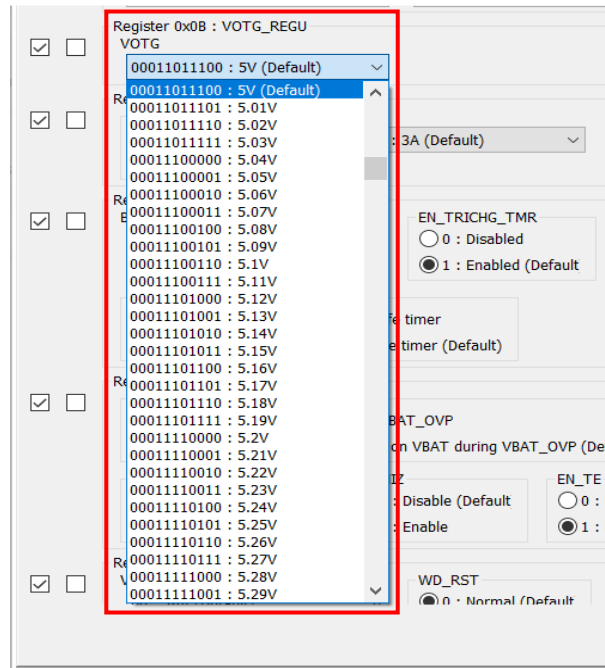

4. Enable EN_OTG. The RT9490 will start to output voltage at the VBUS pin.

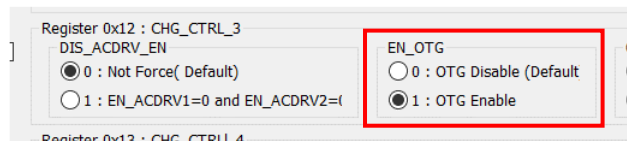

5. On the RT9490 evaluation board, there are mounted AC-RBFETs already. If AC-RBFET is used by jumper setting(see the details in the section” Evaluation Board Jumper Setup”), OTG only starts after the choosed AC-RBFET is turned on.

For example, if VAC1 RBFET is used, EN_ACDRV1 should be enabled. The RT9490 starts to output OTG voltage after register EN_ACDRV1 is set to 1.

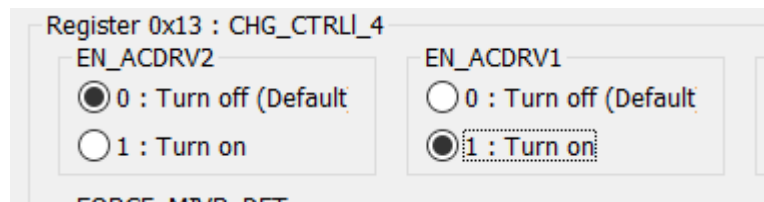

6. Measure the VBUS pin and VAC pin to verify the OTG setting level.

7. After OTG starts, OTG voltage is still able to be set.

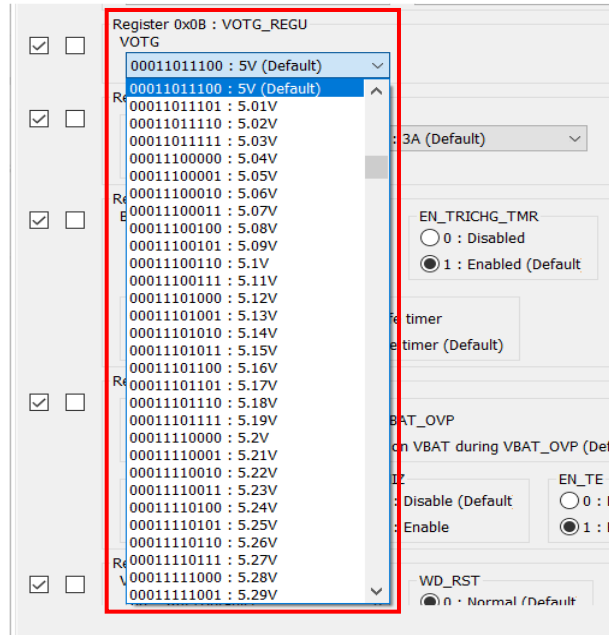

Measure Results Reference

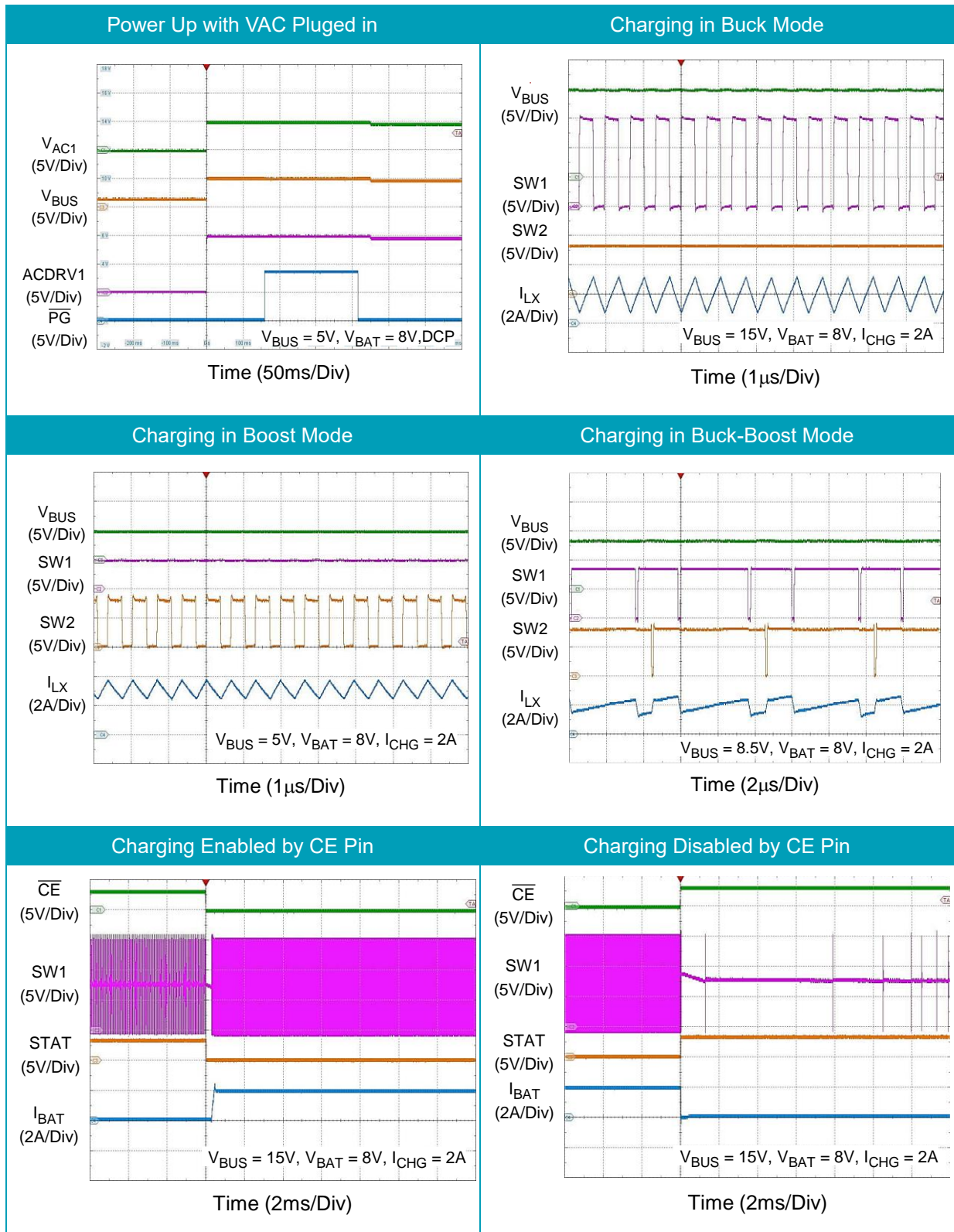

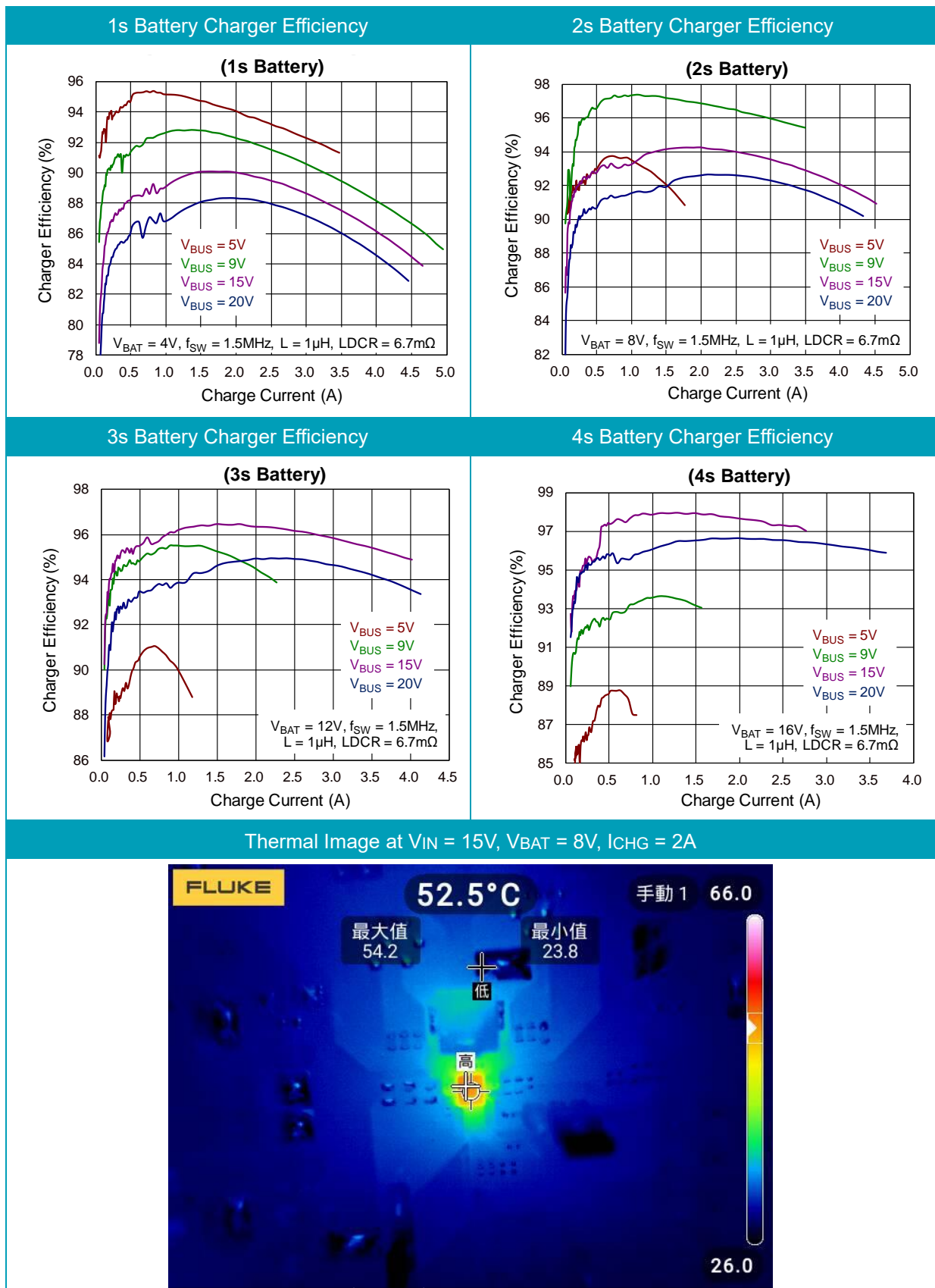

Note: When measuring the input or output voltage ripple, care must be taken to avoid a long ground lead on the oscilloscope probe. Measure the output voltage ripple by touching the probe tip directly across the output capacitor.

Typical Applications

EVB Schematic Diagram

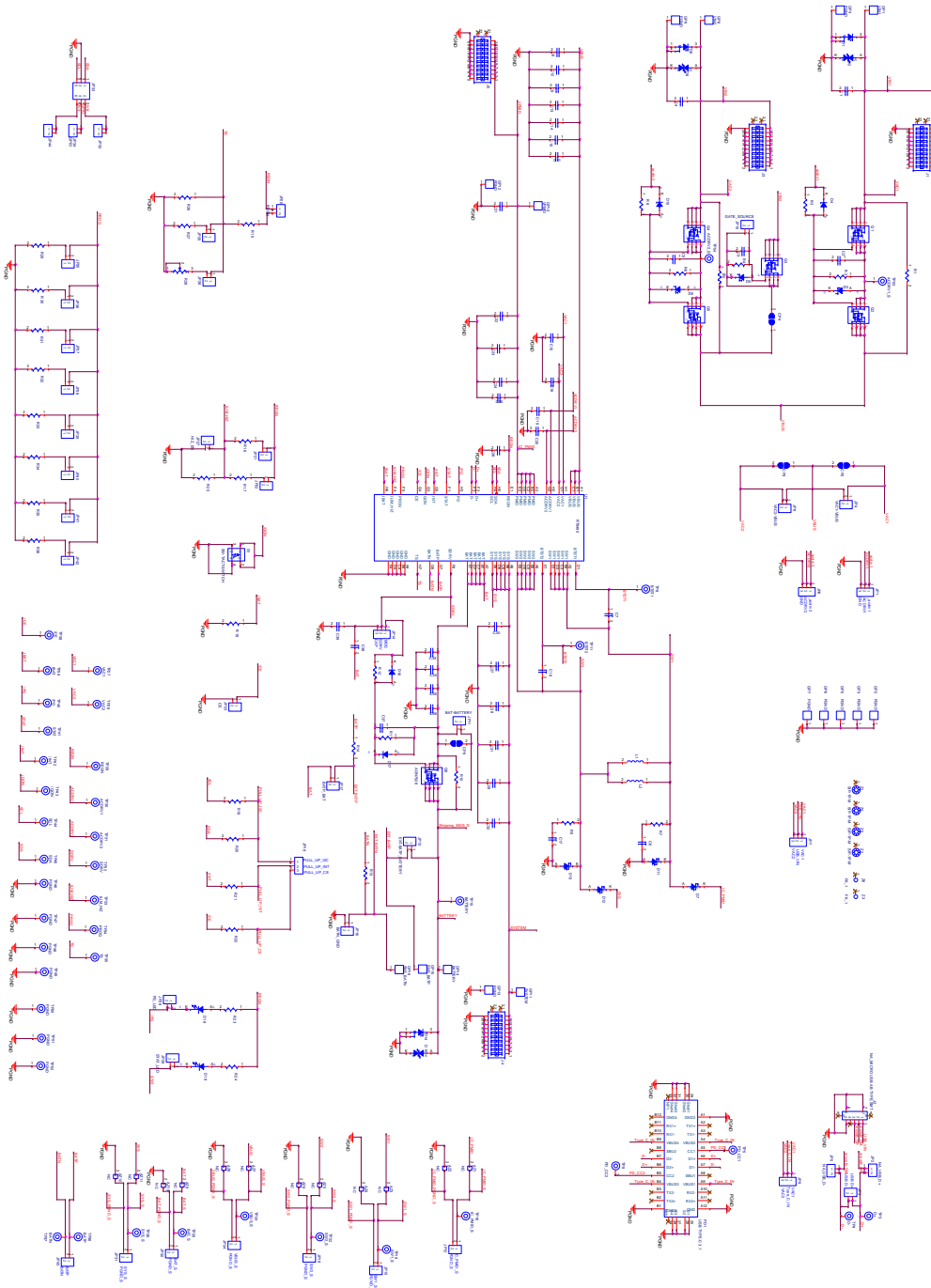

Bill of Materials

fsw = 1.5MHz						
Reference	Count	Part Number	Value	Description	Package	Manufacturer
U1	1	RT9490WSC	--	Switching Charger	WL-CSP-56B 2.93x3.46 (BSC)	RICHTEK
C7, C18	2	GRM033R61C473KE84	47nF	Capacitor, Ceramic, 16V, X5R	C-0201	MURATA
C10, C13, C22, C23, C24	5	GRM188R6YA106MA73	10μF	Capacitor, Ceramic, 35V, X5R	C-0603	MURATA
C11, C25, C30	3	0402B104K500CT	0.1μF	Capacitor, Ceramic, 50V, X7R	C-0402	WALSIN
C26	1	GRM155R60J475ME47D	4.7μF	Capacitor, Ceramic, 6.3V, X5R	C-0402	MURATA
C27, C29, C31, C34, C36	5	GRM188R61E106MA73	10μF	Capacitor, Ceramic, 25V, X5R	C-0603	MURATA
C39	1	0402B102K500CT	1nF	Capacitor, Ceramic, 50V, X7R	C-0402	WALSIN
D18, D19	2	LNL-190SUG	--	LED_GREEN	LED-0603	LighTop
L2	1	PIMB063T-1R0MS-68	1μH	20%/6.7mΩ	L-7-4X6-8	CYNTEC
PD1	1	121U-3CST-09CR	--	USB TYPE-C 3.1	9.87x9.75mm	JEM
Q1, Q2, Q4, Q5	4	AONR36366	--	AONR36366	DFN 3x3 EP	ALPHA & OMEGA SEMICONDUCTOR
Q6	1	AON7528	--	AON7528	DFN 3.3x3.3 EP	ALPHA & OMEGA SEMICONDUCTOR
R12	1	WR06X000 PTL	0	Resistor, Chip, 1/10W, 1%	R-0603	WALSIN
R13, R14	2	WR06X1000FTL	100	Resistor, Chip, 1/10W, 1%	R-0603	WALSIN
R15	1	CR-02FL6---5K1	5.1k	Resistor, Chip, 1/16W, 1%	R-0402	VIKING
R16	1	RTT032553FTP	255k	Resistor, Chip, 1/10W, 1%	R-0603	RALEC
R17	1	WR06X1273FTL	127k	Resistor, Chip, 1/10W, 1%	R-0603	WALSIN
R18, R21, R22, R27	4	WR04X1002FTL	10k	Resistor, Chip, 1/10W, 1%	R-0402	WALSIN
R23, R24	2	CR-02FL6---4K7	4.7k	Resistor, Chip, 1/16W, 1%	R-0402	VIKING

fsw = 1.5MHz						
Reference	Count	Part Number	Value	Description	Package	Manufacturer
R25	1	WR06X1003FTL	100k	Resistor, Chip, 1/10W, 1%	R-0603	WALSIN
R26	1	WR06X3012FTL	30.1k	Resistor, Chip, 1/10W, 1%	R-0603	WALSIN
R29	1	RTT033001FTP	3k	Resistor, Chip, 1/10W, 1%	R-0603	RALEC
R30	1	WR06X4701FTL	4.7k	Resistor, Chip, 1/10W, 1%	R-0603	WALSIN
R31	1	RC0603FR-076K04L	6.04k	Resistor	R-0603	YAGEO
R32	1	WR06X8201FTL	8.2k	Resistor, Chip, 1/10W, 1%	R-0603	WALSIN
R33	1	WR06X1052FTL	10.5k	Resistor, Chip, 1/10W, 1%	R-0603	WALSIN
R34	1	WR06X1372FTL	13.7k	Resistor, Chip, 1/10W, 1%	R-0603	WALSIN
R35	1	WR06X1742FTL	17.4k	Resistor, Chip, 1/10W, 1%	R-0603	WALSIN
R36	1	WR06X2702FTL	27k	Resistor, Chip, 1/10W, 1%	R-0603	WALSIN
S1	1	HTS6601H	--	SW-TACT-SWITCH	TACT-BTN	High-Tronics

Evaluation Board Layout

Figure 1 to Figure 4 are RT9490WSC Evaluation Board layout. This board size is 101.6mm x 101.6mm and is constructed on four-layer PCB, outer layers with 1 oz. Cu and inner layers with 1 oz. Cu.

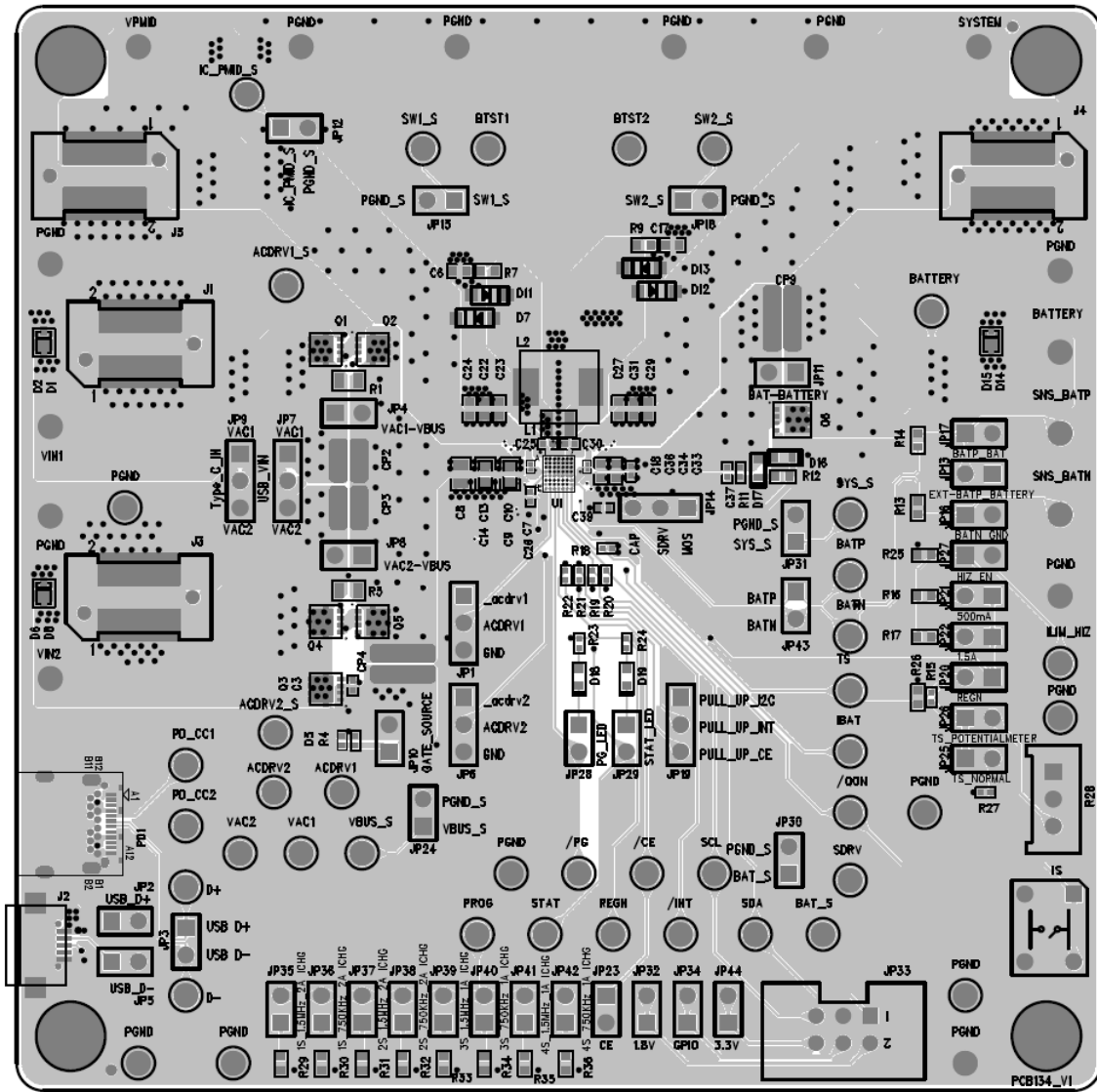

Figure 1. Top View (1st layer)

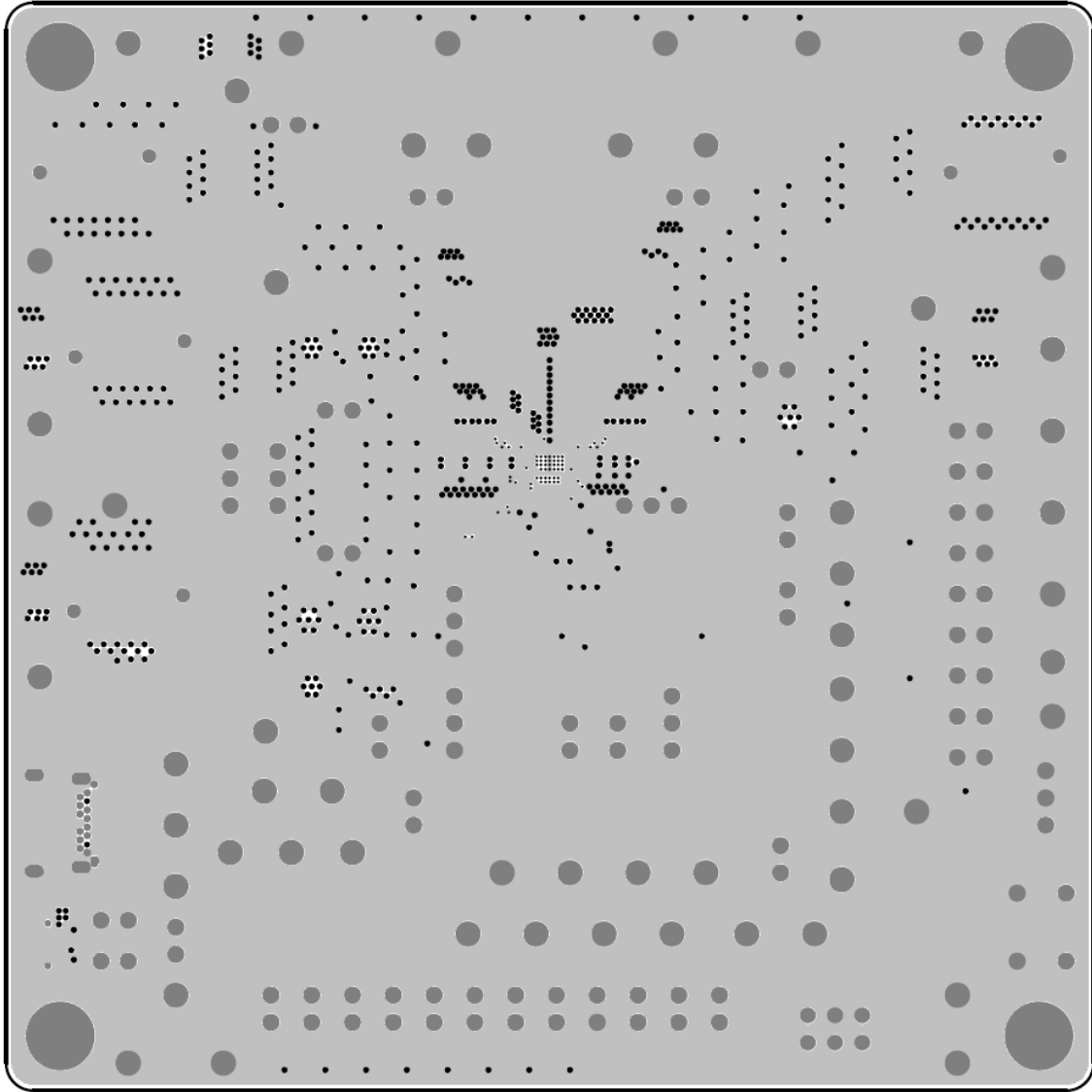

Figure 2. PCB Layout—Inner Side (2nd Layer)

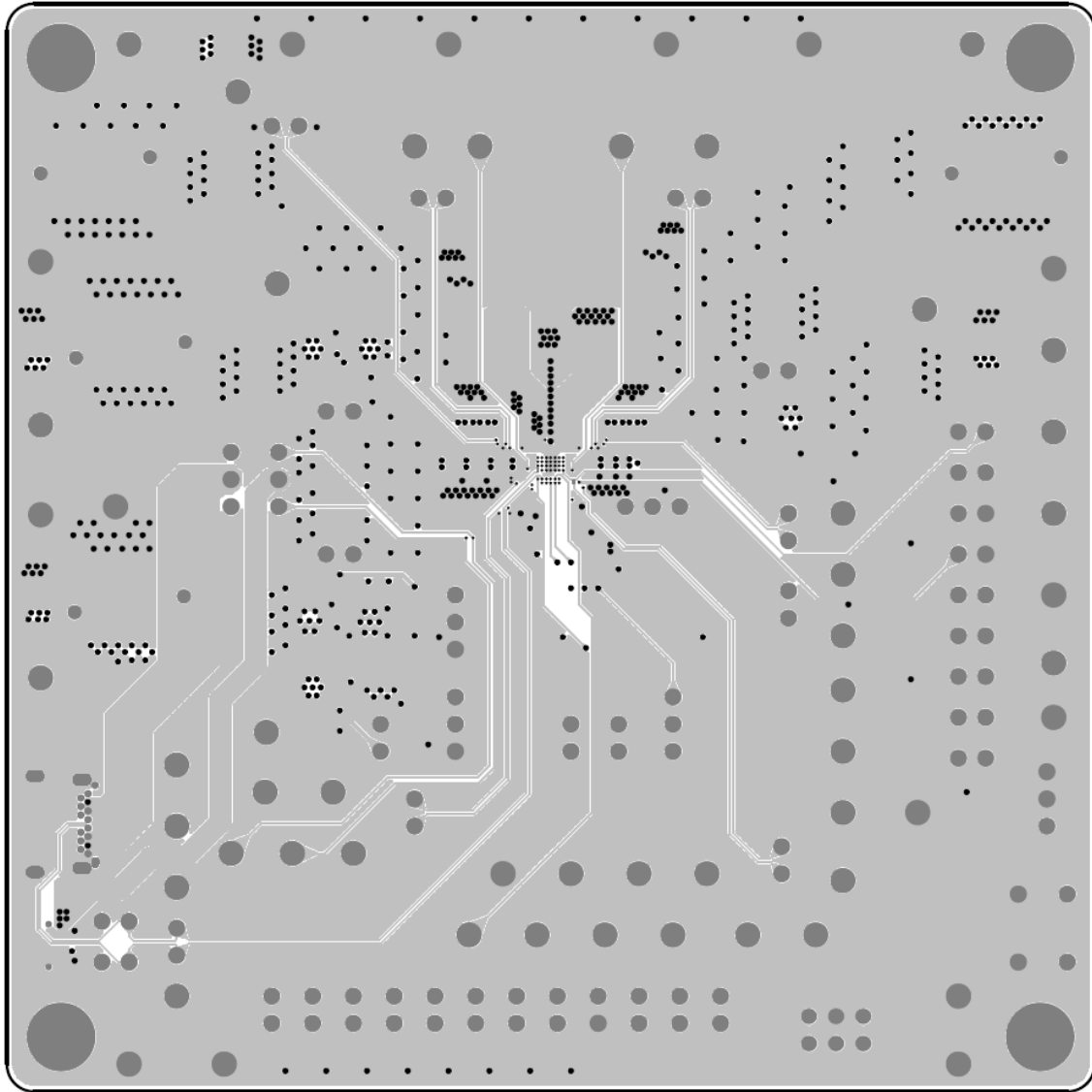

Figure 3. PCB Layout—Inner Side (3rd Layer)

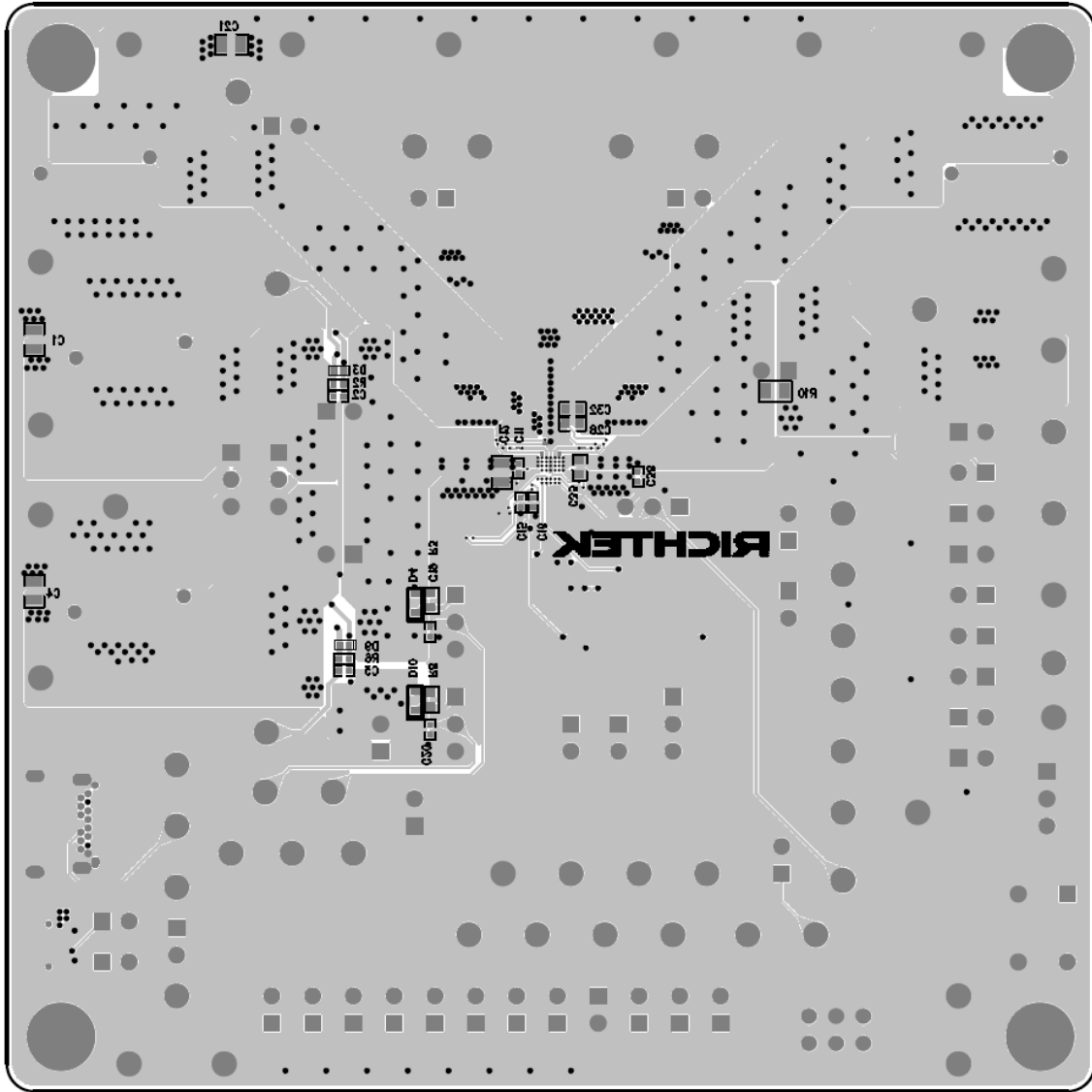

Figure 4. Bottom View (4th Layer)

More Information

For more information, please find the related datasheet or application notes from Richtek website

<http://www.richtek.com>.

Important Notice for Richtek Evaluation Board

THIS DOCUMENT IS FOR REFERENCE ONLY, NOTHING CONTAINED IN THIS DOCUMENT SHALL BE CONSTRUED AS RICHTEK'S WARRANTY, EXPRESS OR IMPLIED, UNDER CONTRACT, TORT OR STATUTORY, WITH RESPECT TO THE PRESENTATION HEREIN. IN NO EVENT SHALL RICHTEK BE LIABLE TO BUYER OR USER FOR ANY AND ALL DAMAGES INCLUDING WITHOUT LIMITATION TO DIRECT, INDIRECT, SPECIAL, PUNITIVE OR CONSEQUENTIAL DAMAGES.